

Detail View C
Scale 5:1

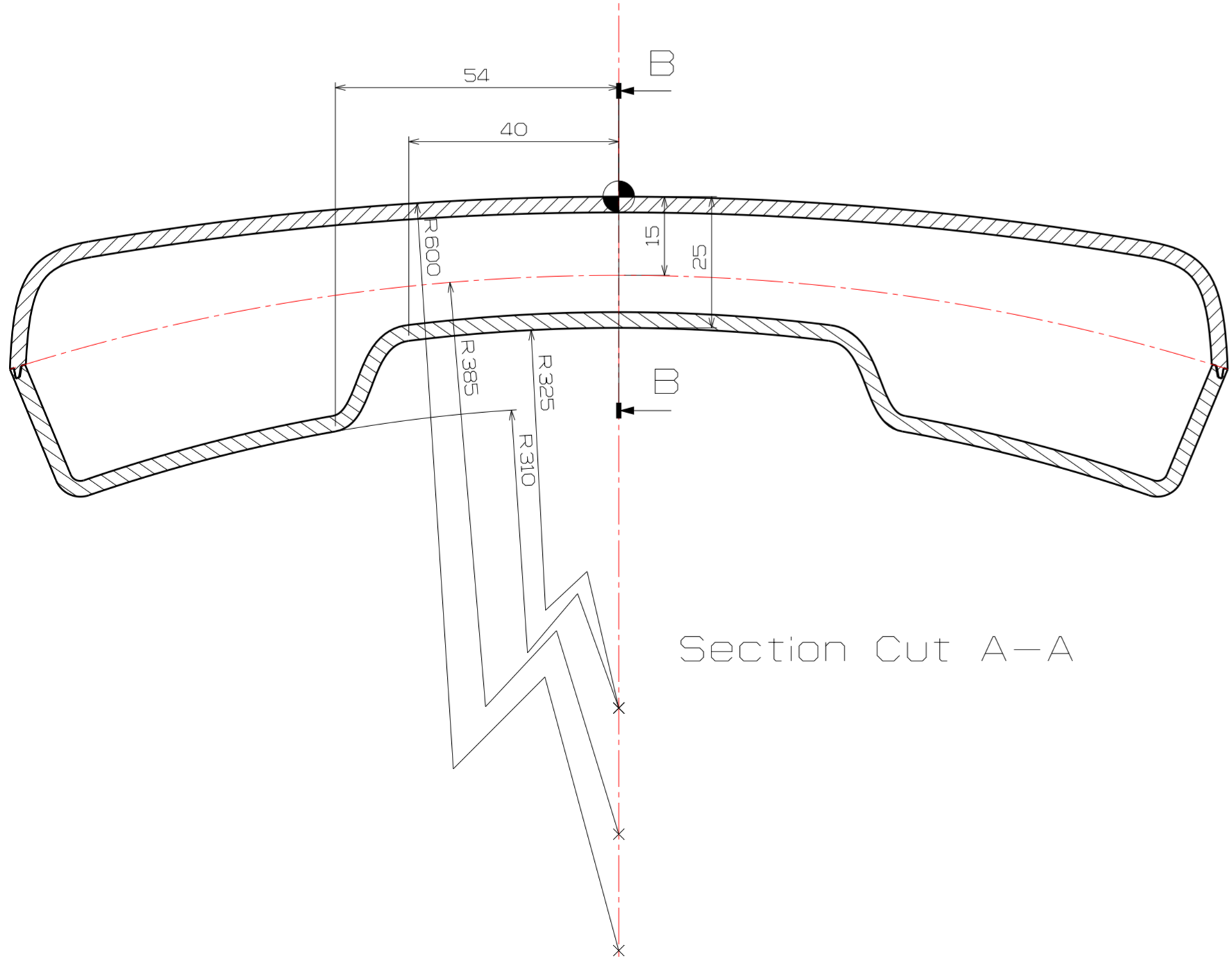

Section Cut A-A

Conic Surface
Hyperbola Section $P=0.6$

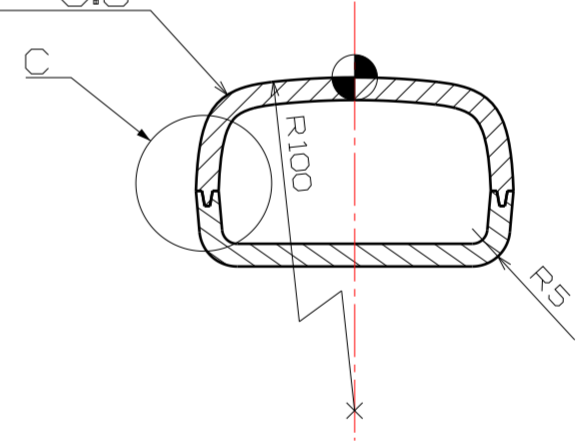

Section Cut B-B

NOTE
1. Top View에서 좌우 상하 대칭 형상임.
2. 제품 두께:3t